



U.S. Department
of Transportation

**National Highway
Traffic Safety
Administration**

400 Seventh Street, S.W.
Washington, D.C. 20590

Dear Crash Data Researchers/Users:

Thank you for choosing crash data from the National Highway Traffic Safety Administration (NHTSA) for your research or other use. The information contained in this motor vehicle crash report is collected, maintained and distributed in accordance with Public Law 89-564. In accordance with this Public Law, NHTSA is required not to release any case information until completion of quality control procedures. These procedures include a review of the case material to extract all names, licenses and registration numbers, non-coded interview material, non-research related researcher comments in the margins, non-factual data, and the production number portion of the vehicle identification number (VIN).

If you requested NHTSA to query its database files in order to identify a specific crash, then that query was made using non-personal descriptors you provided for use in our search. This motor vehicle crash may have been identified from a data search and matches the general, non-personal descriptors you provided, but we cannot confirm that this is the specific crash report you requested.

If you have any questions with regard to the above procedures, please contact the Field Operations Branch, Crash Investigation Division, National Center for Statistics and Analysis at 202-366-4820. Again, please be advised that we cannot confirm that this is the case that you have specifically requested nor can we certify the information to be correct.

*** **



AUTO SAFETY HOTLINE
(800) 424-9393
Wash. D.C. Area 366-0123



PEDESTRIAN CASE SUMMARY

PSU 49 CASE NO. 619P TYPE OF ACCIDENT Car/Ped/Crossing street diagonally

A. DESCRIPTION OF THE ACCIDENT SEQUENCE AND ACCIDENT PECULIARITIES

(Provide a summary of the accident sequence as well as any particular event of the accident that is noteworthy. Pedestrian injury mechanism and vehicle interaction is the focus, not pedestrian or driver culpability. Do not include any personal identifiers.)

Vehicle 1 was traveling east in the only travel lane available, as there were vehicles parked on either side of the street. Ahead of vehicle 1, some boys were playing football in the street. One of the boys was running in a diagonal (northeast) direction and leaped to catch the thrown football. As the pedestrian was returning to ground, vehicle 1 collided with the right leg of the pedestrian. This collision knocked the pedestrian into the air and forward nearly nine meters. The pedestrian then hobbled to the curb. Vehicle 1 drove forward and parked on the south curb. The pedestrian was transported and released then returned to the hospital a week later for surgical repair to his right leg.

B. PEDESTRIAN PROFILE

Pedestrian No.	Age	Sex	Treatment/ Mortality	Most Severe Injury (TO BE COMPLETED BY ZONE CENTER)			
				Body Region	Ana. Struc.	AIS	Injury Source
01	19	M	Treated/ released/ surgery later	Lower Extremity	Skeletal	3	Right side Fender

Body Region

Head
Face
Throat
Chest
Abdomen/Pelvis
Spine
Upper Extremity
Lower Extremity
External

Type of Anatomic Structure

Whole Area
Vessels
Nerves
Organs
Skeletal
Head-LOC
Skin-Burn
Skin-Other

Abbreviated Injury Scale

(1) Minor injury
(2) Moderate injury
(3) Serious injury
(4) Severe injury
(5) Critical injury
(6) Maximum (untreatable)
(7) Injured, unknown severity

C. VEHICLE PROFILE

Vehicle No.	Class of Vehicle	Year/Make/Model	Most Severe Damage Based on Vehicle Inspection	
			Damage Plane	Damage Description
01	Subcompact	92 Mitsubishi Eclipse	Side	Most damage to right fender. Also damage to hood. No damage found on front bumper.

DO NOT SANITIZE THIS FORM

PSU No. 42 Case Number—Stratum 619P Indicate North 

BEST AVAILABLE COPY

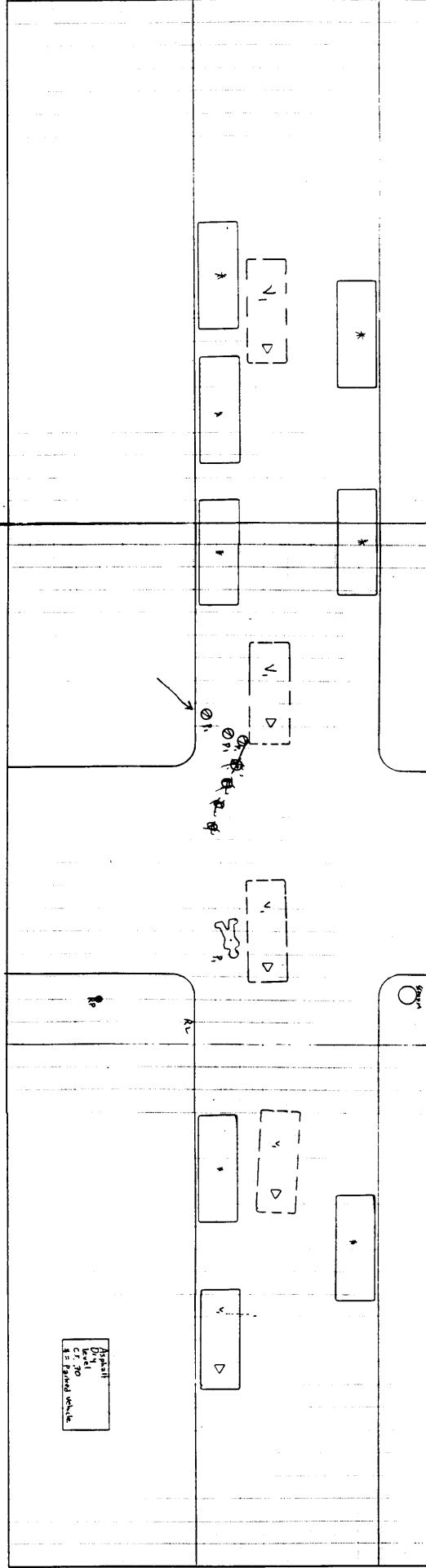



ACCIDENT COLLISION DIAGRAM

PSU No. 49

Case Number—Stratum 619P

Indicate
North

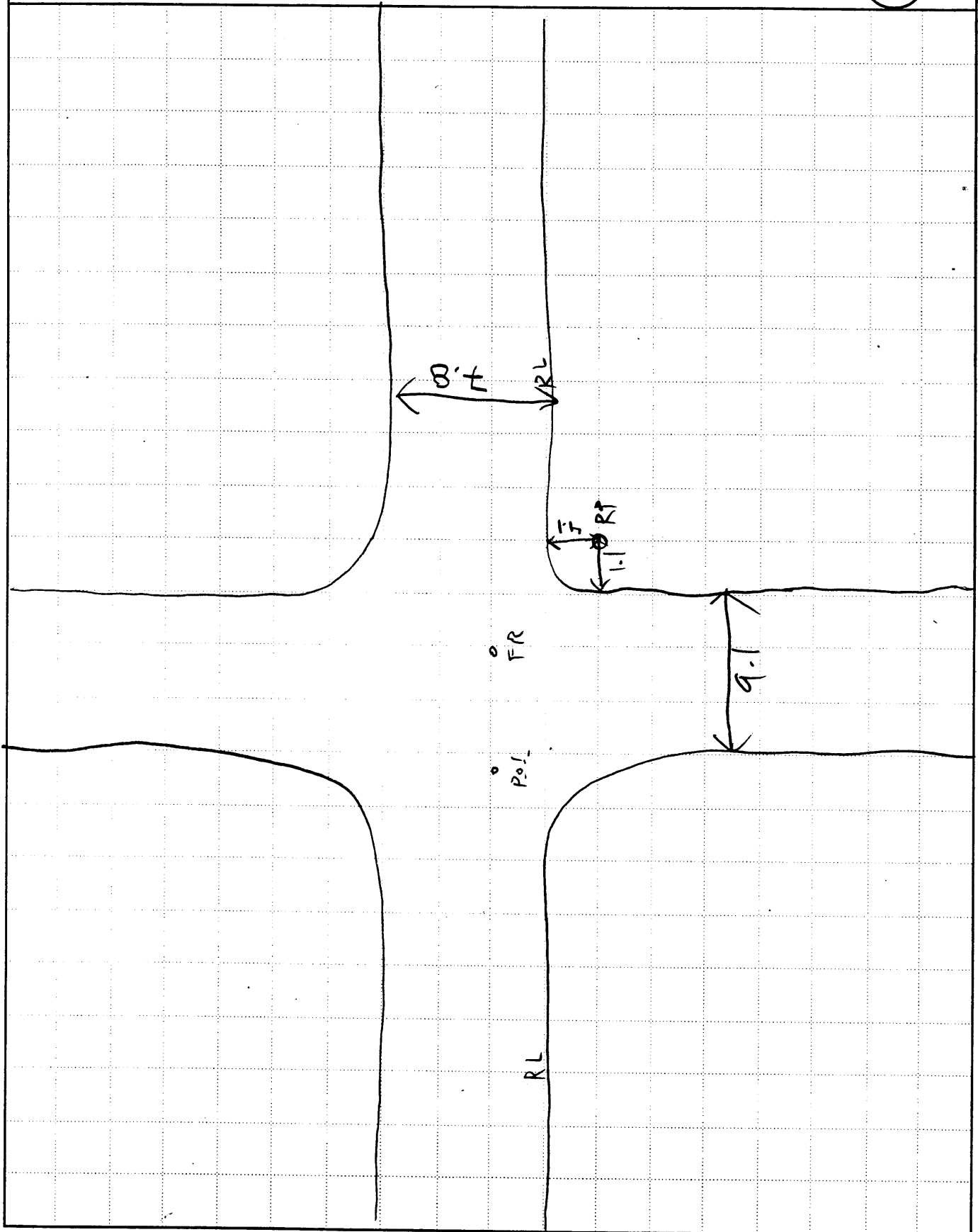
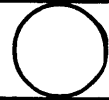

**CODES FOR
CLASS OF VEHICLE**

- (00) Not a motor vehicle
- (01) Subcompact/mini (wheelbase < 254 cm)
- (02) Compact (wheelbase ≥ 254 but < 265 cm)
- (03) Intermediate (wheelbase ≥ 265 but < 278 cm)
- (04) Full size (wheelbase ≥ 278 but < 291 cm)
- (05) Largest (wheelbase ≥ 291 cm)
- (09) Unknown passenger car size
- (11) Compact utility vehicle
- (12) Large utility vehicle (≤ 4,500 kgs GVWR)
- (13) Passenger van (≤ 4,500 kgs GVWR)
- (14) Other van (≤ 4,500 kgs GVWR)
- (15) Pickup truck (≤ 4,500 kgs GVWR)
- (18) Other truck (≤ 4,500 kgs GVWR)
- (19) Unknown light truck type

**CODES FOR GENERAL AREA
OF DAMAGE (GAD)**

**CDS APPLICABLE
VEHICLES**

- (F) Front
- (R) Right side
- (L) Left side
- (U) Undercarriage
- (9) Unknown

CODES FOR VEHICLE NUMBER OR OBJECT CONTACTED

Collision with Nonfixed Object

- (72) Pedestrian



PEDESTRIAN ASSESSMENT FORM

<p>1. Primary Sampling Unit Number <u>49</u></p> <p>2. Case Number - Stratum <u>619P</u></p> <p>3. Pedestrian Number <u>01</u></p>	<p>10. Pedestrian's Weight <u>061</u> Code actual weight to the nearest kilogram. (999) Unknown</p> <p><u>135</u> pounds X .4536 = <u>61.2</u> kilograms</p>
--	--

PEDESTRIAN'S CHARACTERISTICS	PEDESTRIAN'S PRE-AVOIDANCE ACTIONS
------------------------------	------------------------------------

<p>4. Pedestrian's Age <u>19</u> Code actual age at time of accident. (00) Less than one year old (specify by month): (97) 97 years and older (99) Unknown</p> <p>5. Pedestrian's Sex <u>1</u> (1) Male (2) Female - not reported pregnant (3) Female - pregnant-1st trimester (1st-3rd month) (4) Female - pregnant-2nd trimester (4th-6th month) (5) Female - pregnant-3rd trimester (7th-9th month) (6) Female - pregnant-term unknown (9) Unknown</p> <p>6. Pedestrian's Overall Height <u>168</u> Code actual height to the nearest centimeter. (999) Unknown <u>66</u> inches X 2.54 = <u>167.6</u> centimeters</p> <p>7. Pedestrian's Height - Ground to Knee <u>49</u> Code to the nearest centimeter. (999) Unknown _____ inches X 2.54 = _____ centimeters</p> <p>8. Pedestrian's Height - Ground to Hip <u>095</u> Code to the nearest centimeter. (999) Unknown _____ inches X 2.54 = _____ centimeters</p> <p>9. Pedestrian's Height - Ground to Shoulder <u>138</u> Code to the nearest centimeter. (999) Unknown _____ inches X 2.54 = _____ centimeters</p>	<p>11. Pedestrian Attitude <u>1</u> (1) Standing (2) Crouching (3) Kneeling (4) Bending at waist (8) Other (specify): _____ (9) Unknown</p> <p>12. Pedestrian Motion <u>3</u> (0) Not moving (1) Walking slowly (2) Walking rapidly (3) Running or jogging (4) Hopping (5) Skipping (6) Jumping (7) Falling/stumbling or rising (8) Other (specify): _____ (9) Unknown</p> <p>13. Pedestrian's Action Relative to Vehicle <u>02</u> (00) Stopped (01) Crossing road, straight (02) Crossing road, diagonally (03) Moving in road, with traffic (04) Moving in road, against traffic (05) Off road, approaching road (06) Off road, going away from road (07) Off road, moving parallel (08) Off road, crossing driveway (09) Off road, moving along driveway (98) Other (specify): _____ <u>3</u> (99) Unknown</p> <p>14. Pedestrian's Body (Chest) Orientation Relative to Striking Vehicle Prior to Avoidance Actions <u>9</u> <u>X</u> (1) Facing vehicle (2) Facing away (3) Left side to vehicle (4) Right side to vehicle (8) Other (specify): _____ (9) Unknown</p>
---	--

PEDESTRIAN'S AVOIDANCE ACTIONS15. Pedestrian's First Avoidance Actions 00

- (00) No avoidance actions
- (01) Stopped
- (02) Accelerated pace
- (03) Ran away (along vehicle path)
- (04) Jumped
- (05) Turned toward vehicle
- (06) Turned away from vehicle
- (07) Dove or fell away

Used hand(s) to :

- (11) Vault corner of vehicle
- (12) Vault onto vehicle
- (13) Brace against vehicle
- (14) Crouched and braced hands against vehicle
- (98) Other (specify): _____
- (99) Unknown

PEDESTRIAN'S ORIENTATION AT IMPACT16. Pedestrian's Head Orientation at Initial Impact 3

- (1) To front
- (2) To left
- (3) To right
- (4) Up
- (5) Down
- (8) Other (specify): _____
- (9) Unknown

17. Pedestrian's Body (Chest) Orientation at Initial Impact 3

- (1) Facing vehicle
- (2) Facing away
- (3) Left side to vehicle
- (4) Right side to vehicle
- (8) Other (specify): _____
- (9) Unknown

18. Pedestrian's Arm Orientation at Initial Impact 98

- (01) At sides
- (02) Folded across chest
- (03) Hands clasped behind back
- (04) Hands on hips
- (05) Hands in pockets

One or both arms:

- (06) Extended upward
- (07) Extended to side
- (08) Extended forward bracing
- (09) Extended, holding object (briefcase, suitcase, etc.)
- (10) Holding object (young child, grocery bag, etc.) in arm(s)
- (11) Holding object (young child, grocery bag, etc.) on shoulder(s) or head
- (98) Other (specify): extended forward holding ball
- (99) Unknown

19. Pedestrian's Leg Orientation at Initial Impact OK 03

- (01) Together
- (02) Apart-laterally
- (03) Apart-right leg forward
- (04) Apart-left leg forward
- (05) Apart-forward leg unknown
- (06) Left foot off the ground
- (07) Right foot off the ground
- (08) Both feet off the ground
- (98) Other (specify): _____ 14
- (99) Unknown

20. Vehicle/Pedestrian's Interaction OK

- (01) Carried by vehicle, wrapped position
- (02) Carried by vehicle, slid to windshield
- (03) Carried by vehicle, position unknown
- (04) Passed over vehicle top
- (05) Thrown straight forward
- (06) Thrown forward and left of vehicle
- (07) Thrown forward and right of vehicle
- (08) Knocked to pavement, forward
- (09) Knocked to pavement, left of vehicle
- (10) Knocked to pavement, right of vehicle
- (11) Knocked to pavement, run over or dragged by vehicle
- (12) Shunted to left (corner impacts only)
- (13) Shunted to right (corner impacts only)
- (14) Bumped or pushed aside
- (15) Snagged, rotated
- (16) Snagged, dragged by vehicle
- (17) Foot or legs run over
- (98) Other (specify): _____
- (99) Unknown

OFFICIAL RECORDS	INJURY CONSEQUENCES
<p>21. Police Reported Alcohol Presence For Pedestrian <u>0</u> (0) No alcohol present (1) Yes alcohol present (7) Not reported (9) Unknown</p> <p>22. Alcohol Test Result For Pedestrian Code actual value (decimal implied before first digit—0.xx) <u>96</u> (95) Test refused (96) None given (97) AC (Alcohol Content) test performed, results unknown (99) Unknown if test given</p> <p>Source: <u>PAR</u></p> <p>23. Police Reported Other Drug Presence For Pedestrian <u>0</u> (0) No other drug(s) present (1) Yes other drug(s) present (7) Not reported (9) Unknown</p> <p>24. Other Drug Specimen Test Result For Pedestrian <u>0</u> (0) No specimen test given (1) Drug not found in specimen (2) Drug found in specimen, (specify): _____ (3) Specimen test given, results unknown or not obtained (9) Unknown</p>	<p>25. Injury Severity (Police Rating) <u>1</u> (0) O - No injury (1) C - Possible injury (2) B - Nonincapacitating injury (3) A - Incapacitating injury (4) K - Killed (5) U - Injury, severity unknown (6) Died prior to accident (9) Unknown</p> <p>26. Treatment - Mortality <u>4</u> (0) No treatment (1) Fatal (2) Fatal - ruled disease (specify): _____</p> <p style="margin-left: 20px;"><i>Nonfatal</i></p> <p style="margin-left: 20px;">(3) Hospitalization (4) Transported and released (5) Treatment at scene - non-transported (6) Treatment later (8) Treatment - other (specify): _____</p> <p style="margin-left: 20px;">(9) Unknown</p> <p>27. Type Of Medical Facility (for Initial Treatment) <u>1</u> (0) Not treated at a medical facility (1) Trauma center (2) Hospital (3) Medical clinic (4) Physician's office (5) Treatment later at medical facility (8) Other (specify): _____ (9) Unknown</p> <p>28. Hospital Stay <u>00</u> (00) Not Hospitalized _____ Code the number of days (up through 60) that the pedestrian stayed in a hospital. (61) 61 days or more (99) Unknown</p> <p>29. Working Days Lost <u>99</u> _____ Code the number of days (up through 60) that the pedestrian lost from work due to the accident (00) No working days lost (61) 61 days or more (62) Fatally injured (97) Not working prior to accident (99) Unknown</p>

STOP - VARIABLES 30 THROUGH 37 ARE COMPLETED BY THE ZONE CENTER

30. Glasgow Coma Scale (GCS) Score 02
 (at Medical Facility)
 (00) Not injured
 (01) Injured - not treated at medical facility
 (02) No GCS Score at medical facility
 (03-15) Code the actual value of the initial GCS Score recorded at medical facility.
 (97) Injured, details unknown
 (99) Unknown if injured

31. Was the Pedestrian Given Blood? 1
 (1) No - blood not given
 (2) Yes - blood given (specify units): _____
 (9) Unknown if blood given

32. Arterial Blood Gases (ABG) – HCO₃ 01
 (00) Not injured
 (01) Injured, ABGs not measured or reported
 (02-50) Code the actual value of the HCO₃
 (96) ABGs reported, HCO₃ unknown
 (97) Injured, details unknown
 (99) Unknown if injured

33. Time to Death 00
 _____ Code number of hours from time of accident to time of death up through 24 hours. If time of death is greater than 24 hours, code number of days. (Note: 1 day = 31, 2 days = 32, ... n days = 30 + n up through 30 days = 60)
 (00) Not fatal
 (96) Fatal - ruled disease
 (99) Unknown

34. 1st Medically Reported Cause of Death 00

35. 2nd Medically Reported Cause of Death 00

36. 3rd Medically Reported Cause of Death 00
 _____ Code the Pedestrian Injury from line number(s) for the medically reported injury(s) which reportedly contributed to this pedestrian's death
 (00) Not fatal or no additional causes
 (96) Mode of death given but specific injuries are not linked to cause of death. (specify): _____
 (97) Other result (includes fatal ruled disease) (specify): _____
 (99) Unknown

37. Number of Recorded Injuries for This Pedestrian 07
 _____ Code the actual number of injuries recorded for this pedestrian.
 (00) No recorded injuries
 (97) Injured, details unknown
 (99) Unknown if injured

ARE ALL APPLICABLE MEDICAL RECORDS INCLUDED WITH INITIAL SUBMISSION?

NO [] YES []

UPDATE CANDIDATE? NO [] YES []



PEDESTRIAN INJURY FORM

1. Primary Sampling Unit Number <u>49</u>	3. Pedestrian Number <u>01</u>
2. Case Number - Stratum <u>619P</u>	4. Blank <u>XX</u>

INJURY DATA

Record below the actual injuries sustained by this pedestrian in **CHRONOLOGICAL** order that were identified from the official and unofficial data sources. Remember not to double count an injury just because it was identified from two different sources. If greater than twenty-five injuries have been documented, encode the balance on the Pedestrian Injury Supplement.

	AIS-90								Injury Source	Injury Confidence Level	Direct/Indirect Injury	Striking Profile	Type Of Damage	Damage Depth
	Source of Injury Data	Body Region	Type of Anatomic Structure	Specific Anatomic Structure	Level of Injury	A.I.S. Severity	Aspect	Injury Source						
1st	5. <u>2</u>	6. <u>8</u>	7. <u>9</u>	8. <u>02</u>	9. <u>02</u>	10. <u>1</u>	11. <u>1</u>	12. <u>740</u>	13. <u>1</u>	14. <u>1</u>	15. <u>3</u>	16. <u>2</u>	17. <u>2</u>	
2nd	18. <u>7</u>	19. <u>8</u>	20. <u>9</u>	21. <u>04</u>	22. <u>02</u>	23. <u>1</u>	24. <u>1</u>	25. <u>740</u>	26. <u>1</u>	27. <u>1</u>	28. <u>3</u>	29. <u>2</u>	30. <u>2</u>	
3rd	31. <u>7</u>	32. <u>8</u>	33. <u>9</u>	34. <u>06</u>	35. <u>02</u>	36. <u>1</u>	37. <u>1</u>	38. <u>740</u>	39. <u>1</u>	40. <u>1</u>	41. <u>3</u>	42. <u>2</u>	43. <u>2</u>	
4th	44. <u>2</u>	45. <u>8</u>	46. <u>5</u>	47. <u>34</u>	48. <u>08</u>	49. <u>3</u>	50. <u>1</u>	51. <u>740</u>	52. <u>1</u>	53. <u>1</u>	54. <u>2</u>	55. <u>3</u>	56. <u>3</u>	
5th	57. <u>7</u>	58. <u>8</u>	59. <u>9</u>	60. <u>04</u>	61. <u>02</u>	62. <u>1</u>	63. <u>1</u>	64. <u>791</u>	65. <u>2</u>	66. <u>1</u>	67. <u>2</u>	68. <u>2</u>	69. <u>2</u>	
6th	70. <u>7</u>	71. <u>5</u>	72. <u>9</u>	73. <u>02</u>	74. <u>02</u>	75. <u>1</u>	76. <u>1</u>	77. <u>752</u>	78. <u>1</u>	79. <u>1</u>	80. <u>3</u>	81. <u>2</u>	82. <u>2</u>	
7th	83. <u>7</u>	84. <u>7</u>	85. <u>9</u>	86. <u>02</u>	87. <u>02</u>	88. <u>1</u>	89. <u>1</u>	90. <u>947</u>	91. <u>1</u>	92. <u>1</u>	93. <u>0</u>	94. <u>0</u>	95. <u>0</u>	
8th	96. <u> </u>	97. <u> </u>	98. <u> </u>	99. <u> </u>	100. <u> </u>	101. <u> </u>	102. <u> </u>	103. <u> </u>	104. <u> </u>	105. <u> </u>	106. <u> </u>	107. <u> </u>	108. <u> </u>	
9th	109. <u> </u>	110. <u> </u>	111. <u> </u>	112. <u> </u>	113. <u> </u>	114. <u> </u>	115. <u> </u>	116. <u> </u>	117. <u> </u>	118. <u> </u>	119. <u> </u>	120. <u> </u>	121. <u> </u>	
10th	122. <u> </u>	123. <u> </u>	124. <u> </u>	125. <u> </u>	126. <u> </u>	127. <u> </u>	128. <u> </u>	129. <u> </u>	130. <u> </u>	131. <u> </u>	132. <u> </u>	133. <u> </u>	134. <u> </u>	

OFFICIAL INJURY DATA — SOFT TISSUE INJURIES

Indicate the Location, Specific Anatomic Structure, Detail (size, depth, fracture type, head injury clinical signs and neurological deficits), and Source of all injuries indicated by official sources (or from PAR or other unofficial sources if medical records and interviewee data are unavailable.)

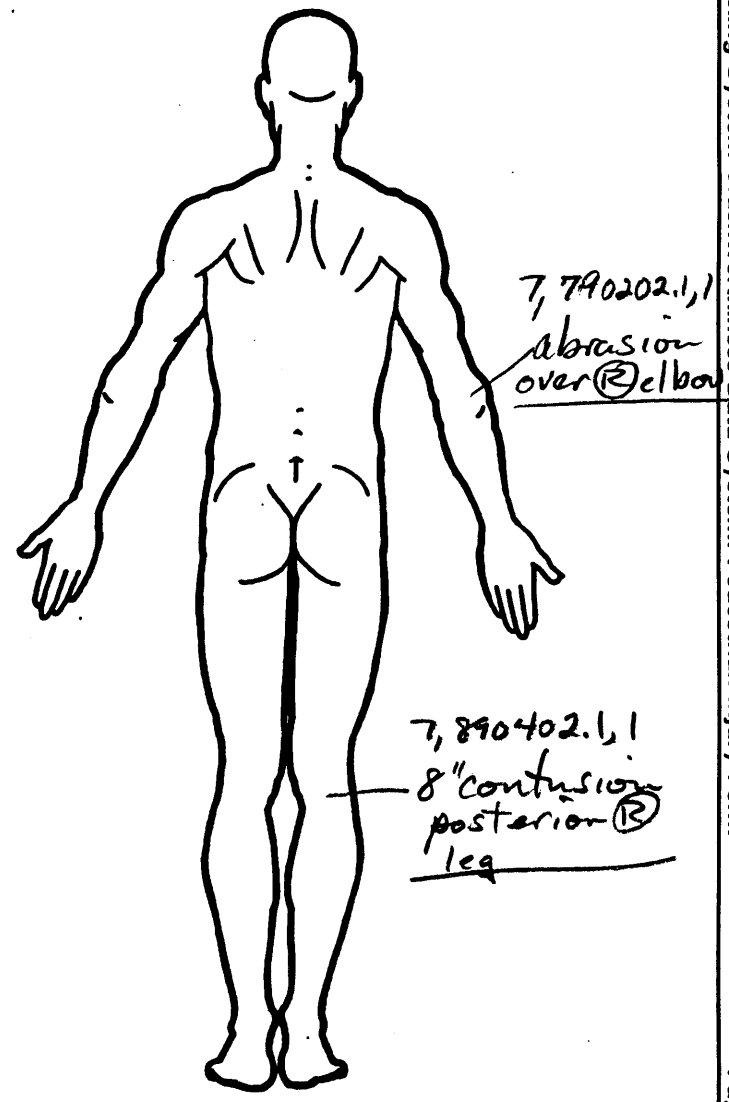
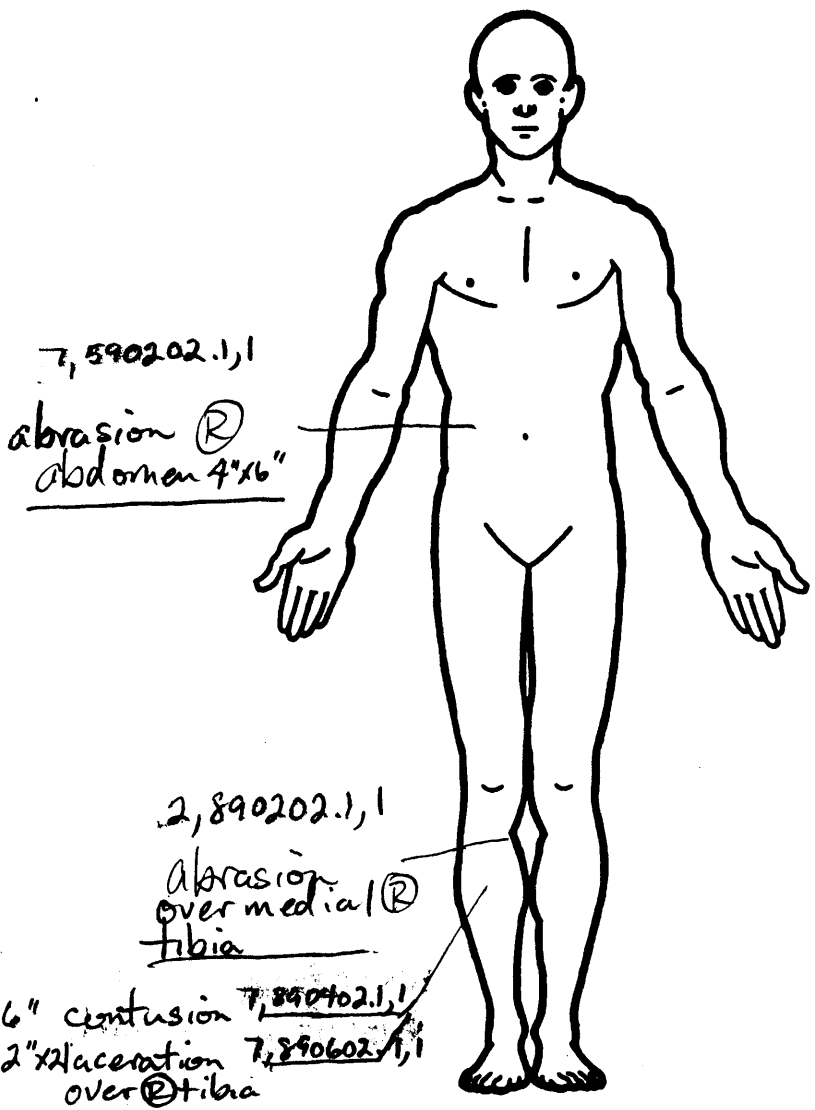

<p>SOURCE OF INJURY DATA</p> <p>OFFICIAL</p> <p>(1) Autopsy records with or without hospital/ medical records</p> <p>(2) Hospital/medical records other than emergency room (e.g., discharge summary)</p> <p>(3) Emergency room records only (including associated X-rays or other lab reports)</p> <p>(4) Private physician, walk-in or emergency clinic</p> <p>UNOFFICIAL</p> <p>(5) Lay coroner report</p> <p>(6) E.M.S. personnel</p> <p>(7) Interviewee</p> <p>(8) Other source (specify): _____</p> <p>(9) Police</p>	<p>INJURY SOURCE CONFIDENCE LEVEL</p> <p>(1) Certain</p> <p>(2) Probable</p> <p>(3) Possible</p> <p>(9) Unknown</p> <p>DIRECT/INDIRECT INJURY</p> <p>(1) Direct contact injury</p> <p>(2) Indirect contact injury</p> <p>(3) Noncontact injury</p> <p>(7) Injured, unknown source</p> <p>STRIKING PROFILE</p> <p>(0) Injury not from vehicle contact</p> <p>(1) Flat-Narrow (< 15 centimeters)</p> <p>(2) Flat-Wide (≥ 15 centimeters)</p> <p>(3) Rounded (contoured)</p> <p>(4) Rounded edge</p> <p>(5) Sharp edge</p> <p>(8) Other (specify): _____</p> <p>(9) Unknown</p>	<p>TYPE OF DAMAGE</p> <p>(0) Injury not from vehicle contact</p> <p>(1) No damage/contact</p> <p>(2) Scratch (Scuff, Cloth Transfer, Smear)</p> <p>(3) Dent</p> <p>(4) Large deformation</p> <p>(5) Cracked, fractured, shattered</p> <p>(6) Separated from vehicle</p> <p>(7) Noncontact injury</p> <p>(8) Other specify: _____</p> <p>(9) Unknown</p> <p>DAMAGE DEPTH</p> <p>(0) Injury not from vehicle contact</p> <p>(1) No residual damage</p> <p>(2) Surface only damage</p> <p>(3) Crush depth > 0 to 2 centimeters</p> <p>(4) Crush depth > 2 to 5 centimeters</p> <p>(5) Crush depth > 5 to 10 centimeters</p> <p>(8) Other specify: _____</p> <p>(9) Unknown</p>
--	--	--

PEDESTRIAN INJURY CLASSIFICATION

Body Region	Specific Anatomic Structure	Spine	Abbreviated Injury Scale
(1) Head (2) Face (3) Neck (4) Thorax (5) Abdomen (6) Spine (7) Upper Extremity (8) Lower Extremity (9) Unspecified	<u>Whole Area</u> (02) Skin - Abrasion (04) Skin - Contusion (06) Skin - Laceration (08) Skin - Avulsion (10) Amputation (20) Burn (30) Crush (40) Degloving (50) Injury - NFS (90) Trauma, other than mechanical	(02) Cervical (04) Thoracic (06) Lumbar	(1) Minor injury (2) Moderate injury (3) Serious injury (4) Severe injury (5) Critical injury (6) Maximum (untreatable) (7) Injured, unknown severity
Type of Anatomic Structure	<u>Head - LOC</u> (02) Length of LOC (04, 06, 08) Level of Consciousness (10) Concussion	<u>Vessels, Nerves, Organs, Bones, Joints</u> are assigned consecutive two digit numbers beginning with 02	Aspect (1) Right (2) Left (3) Bilateral (4) Central (5) Anterior (6) Posterior (7) Superior (8) Inferior (9) Unknown (0) Whole region
(1) Whole Area (2) Vessels (3) Nerves (4) Organs (includes muscles/ ligaments) (5) Skeletal (includes joints) (6) Head - LOC (9) Skin		Level of Injury Specific injuries are assigned consecutive two-digit numbers beginning with 02. To the extent possible, within the organizational framework of the AIS, 00 is assigned to an injury NFS as to severity or where only one injury is given in the dictionary for that anatomic structure. 99 is assigned to any injury NFS as to lesion or severity.	

INJURY SOURCE

<p>FRONT</p> <p>700 Front bumper</p> <p>701 Front lower valance/spoiler</p> <p>702 Front grille</p> <p>703 Hood edge and/or trim</p> <p>704 Hood ornament (fixed)</p> <p>705 Hood ornament (spring loaded)</p> <p>706 Headlight</p> <p>707 Retractable headlight door (Open/Closed)</p> <p>708 Turn signal/parking lights</p> <p>718 Other front or add on object (specify): _____</p> <p>719 Unknown front object</p> <p>Left Side Components</p> <p>720 Front fender side surface</p> <p>721 Front antenna</p> <p>722 A1 pillar</p> <p>723 A2 pillar</p> <p>724 B pillar</p> <p>725 C pillar</p> <p>726 D pillar</p> <p>728 Other pillar (specify): _____</p> <p>729 Left side roof rail</p> <p>730 Left side door surface</p> <p>731 Left side door handle</p> <p>732 Left side mirror fixed housing</p> <p>733 Left side folding mirror</p> <p>734 Left side glazing forward of B pillar</p> <p>735 Left side glazing rearward of B pillar</p> <p>736 Left side back fender or quarter panel</p> <p>737 Rear antenna</p> <p>738 Other left side object (specify): _____</p> <p>739 Unknown left side component</p> <p>Right Side Components</p> <p>740 Front fender side surface</p> <p>741 Front antenna</p> <p>742 A1 pillar</p> <p>743 A2 pillar</p>	<p>744 B pillar</p> <p>745 C pillar</p> <p>746 D pillar</p> <p>748 Other pillar (specify): _____</p> <p>749 Right side roof rail</p> <p>750 Right side door surface</p> <p>751 Right side door handle</p> <p>752 Right side mirror fixed housing</p> <p>753 Right side folding mirror</p> <p>754 Right side glazing forward of B pillar</p> <p>755 Right side glazing rearward of B pillar</p> <p>756 Rear antenna</p> <p>757 Rear fender or quarter panel</p> <p>758 Other right side object (specify): _____</p> <p>759 Unknown right side component</p> <p>Back Components</p> <p>760 Rear (back) bumper</p> <p>761 Tailgate</p> <p>762 Hatchback, vertical surface</p> <p>768 Other back component (specify): _____</p> <p>769 Unknown back component</p> <p>Top Components</p> <p>770 Hood surface</p> <p>771 Hood surface reinforced by under hood component</p> <p>772 Front fender top surface</p> <p>773 Cowl area</p> <p>774 Wiper blade & mountings</p> <p>775 Windshield glazing</p> <p>776 Front header</p> <p>777 Roof surface</p> <p>778 Backlight glazing</p> <p>779 Rear header</p> <p>780 Hatchback</p> <p>781 Rear trunk lid</p> <p>788 Other top component (specify): _____</p> <p>789 Unknown top component</p>	<p>Wheels / tires</p> <p>790 Left front wheel / tire</p> <p>791 Right front wheel / tire</p> <p>792 Left rear wheel / tire</p> <p>793 Right rear wheel / tire</p> <p>798 Other wheel / tire (specify): _____</p> <p>799 Unknown wheel / tire</p> <p>Undercarriage components</p> <p>800 Front crossmember</p> <p>801 Steering assembly/Front suspension</p> <p>802 Oil pan</p> <p>803 Exhaust system pipe</p> <p>804 Transmission</p> <p>805 Drive shaft</p> <p>806 Catalytic converter</p> <p>807 Muffler</p> <p>808 Floor pan</p> <p>809 Fuel tank</p> <p>810 Rear suspension</p> <p>818 Other undercarriage component (specify): _____</p> <p>819 Unknown undercarriage component</p> <p>Accessories</p> <p>820 Air scoop, deflector</p> <p>821 Cellular or CB radio antenna</p> <p>822 Emergency lights or bar</p> <p>823 Fog lights</p> <p>824 Luggage, ski, or bike rack</p> <p>825 Cargo (specify): _____</p> <p>826 Spare tire</p> <p>827 Spotlight</p> <p>828 Other accessory (specify): _____</p> <p>Other Object or Vehicle in Environment</p> <p>947 Ground</p> <p>948 Other object (specify): _____</p> <p>949 Unknown object in environment</p> <p>959 Unknown object on contacting vehicle</p> <p>997 Noncontact injury source</p> <p>999 Unknown injury source</p>
--	--	--

OFFICIAL INJURY DATA — SKELETAL INJURIES

Restrained?

No
 Yes

Indicate the Location, Specific Anatomic Structure, Detail (size, depth, fracture type, head injury clinical signs and neurological deficits), and Source of all injuries indicated by official sources (or from PAR or other unofficial sources if medical records and interviewee data are unavailable.)

Blood Alcohol Level (mg/dl)

BAL = ?

Glasgow Coma Scale Score

GCSS = unk no records from initial treatm.

Units of Blood Given

Units =

Arterial Blood Gases

Ph =

PO₂ =

PCO₂ =

HCO₃ =

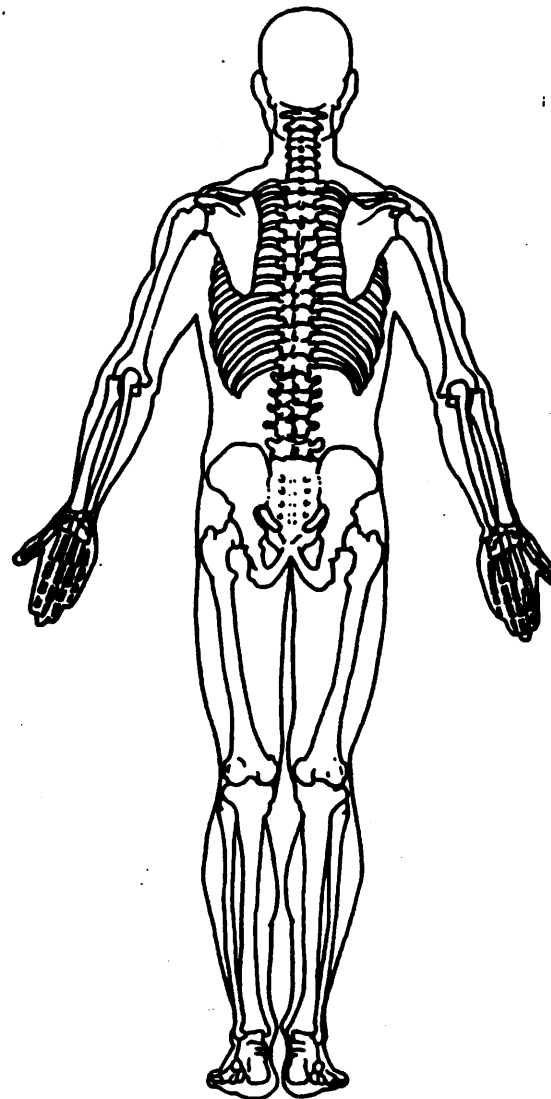
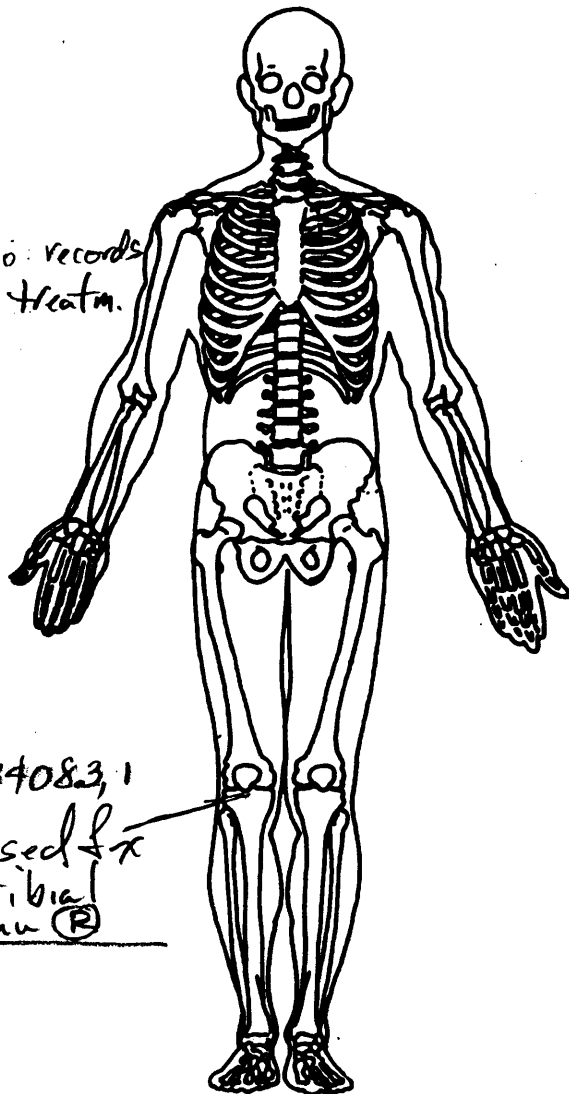

OFFICIAL INJURY DATA — INTERNAL INJURIES

Indicate the Location, Specific Anatomic Structure, Detail (size, depth, fracture type, head injury clinical signs and neurological deficits), and Source of all injuries indicated by official sources (or from PAR or other unofficial sources if medical records and interviewee data are unavailable.)

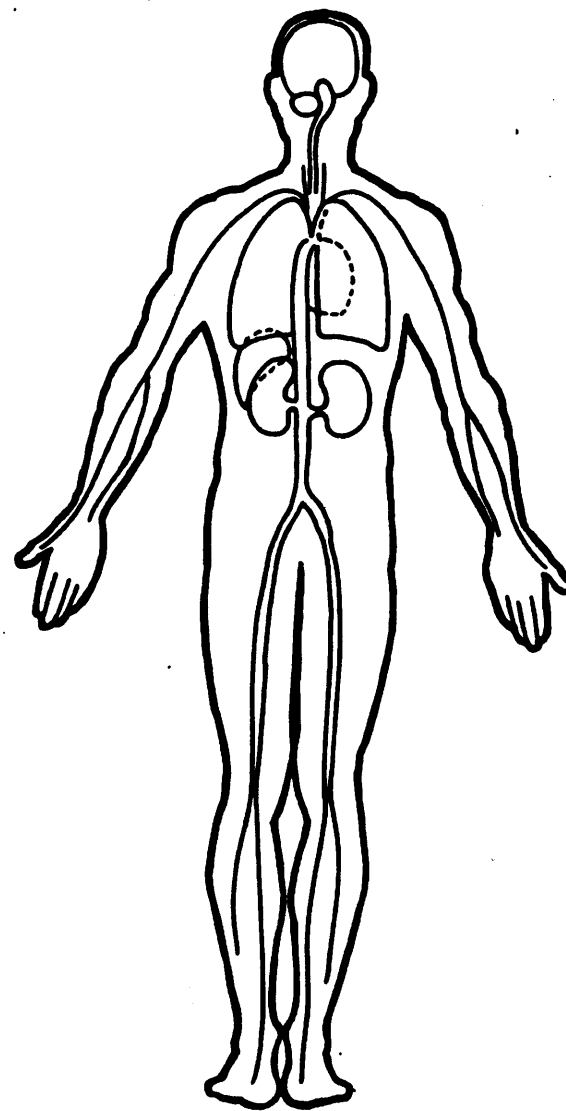
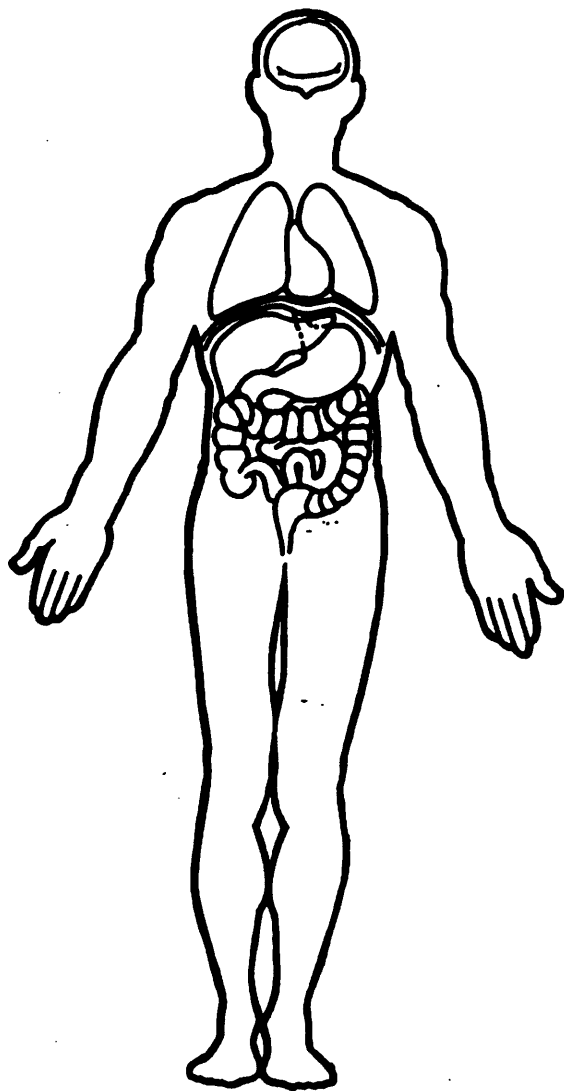



OFFICIAL RECORDS

1. Primary Sampling Unit Number 49
 2. Case Number - Stratum 619P
 3. Vehicle Number 01

9. Police Reported Travel Speed 048
 Code to the nearest kmph (NOTE: 000 means less than 0.5 kmph)
 (160) 159.5 kmph and above
 (999) Unknown

30 mph X 1.6093 = 048 kmph

VEHICLE IDENTIFICATION

4. Vehicle Model Year 92
 Code the last two digits of the model year
 (99) Unknown

10. Speed Limit 048
 (000) No statutory limit
 Code posted or statutory speed limit in kmph
 (999) Unknown

30 mph X 1.6093 = 048 kmph

5. Vehicle Make (specify): Mitsubishi 52
 Applicable codes are found in your NASS PCDS Data Collection, Coding and Editing Manual.
 (99) Unknown

11. Police Reported Alcohol Presence For Driver 0
 (0) No alcohol present
 (1) Yes alcohol present
 (7) Not reported
 (8) No driver present
 (9) Unknown

6. Vehicle Model (specify): Eclipse 037
 Applicable codes are found in your NASS PCDS Data Collection, Coding and Editing Manual.
 (999) Unknown

12. Alcohol Test Result For Driver 96
 Code actual value (decimal implied before first digit—0.xx)
 (95) Test refused
 (96) None given
 (97) AC (Alcohol Content) test performed, results unknown
 (98) No driver present
 (99) Unknown

Source: PAR

7. Body Type 03
 Note: Applicable codes may be found on the back of this page.

8. Vehicle Identification Number
4A3CS34T7NE [REDACTED]
 1 2 3 4 5 6 7 8 9 10 11 12 13 14 15 16 17

13. Police Reported Other Drug Presence For Driver 0
 (0) No other drug(s) present
 (1) Yes other drug(s) present
 (7) Not reported
 (8) No driver present
 (9) Unknown

Left justify; Slash zeros and letter Z (Ø and Z)
 No VIN—Code all zeros
 Unknown—Code all nines

14. Other Drug Specimen Test Result For Driver 0
 (0) No specimen test given
 (1) Drug not found in specimen
 (2) Drug found in specimen (specify): _____
 (3) Specimen test given, results unknown or not obtained
 (8) No driver present
 (9) Unknown

CODES FOR BODY TYPE

CDS APPLICABLE VEHICLES

Automobiles

- (01) Convertible (excludes sun-roof, t-bar)
- (02) 2-door sedan, hardtop, coupe
- (03) 3-door/2-door hatchback
- (04) 4-door sedan, hardtop
- (05) 5-door/4-door hatchback
- (06) Station wagon (excluding van and truck based)
- (07) Hatchback, number of doors unknown
- (08) Other automobile type (specify): _____
- (09) Unknown automobile type

Automobile Derivatives

- (10) Auto based pickup (includes El Camino, Caballero, Ranchero, Brat, and Rabbit pickup)
- (11) Auto based panel (cargo station wagon, auto based ambulance/hearse)
- (12) Large limousine - more than four side doors or stretched chassis
- (13) Three-wheel automobile or automobile derivative

Utility Vehicles ($\leq 4,500$ kgs GVWR)

- (14) Compact utility (Jeep CJ-2 - CJ-7, Scrambler, Golden Eagle, Renegade, Laredo, Wrangler, Cherokee [84 and after], Dispatcher, Raider, Bronco II, Bronco [76 and before], Explorer, S-10 Blazer, Geo Tracker, Bravada, S-15 Jimmy, Thing, Pathfinder, Trooper, Trooper II, Rodeo, Amigo, Navajo, 4-Runner, Montero, Samurai, Sidekick, Rocky)
- (15) Large utility (includes Jeep Cherokee [83 and before], Ramcharger, Trailduster, Bronco-fullsize [78 and after], fullsize Blazer, fullsize Jimmy, Landcruiser, Rover, Scout)
- (16) Utility station wagon (Chevy Suburban, GMC Suburban, Travelall, Grand Wagoneer, includes suburban limousine)
- (19) Utility, unknown body type

Van Based Light Trucks ($\leq 4,500$ kgs GVWR)

- (20) Minivan (Chrysler Town and Country, Caravan, Grand Caravan, Voyager, Grand Voyager, Mini-Ram, Dodge/Plymouth Vista, Aerostar, Villager, Lumina APV, Trans Sport, Silhouette, Astro, Safari, Toyota Van, Toyota Minivan, Previa, Nissan Minivan, Quest, Mitsubishi Minivan, Vanagon/Camper.)
- (21) Large van (B150-B350, Sportsman, Royal, Maxiwagon, Ram, Tradesman, Voyager [83 and before], E150-E350, Econoline, Clubwagon, Chateau, G10-G30, Chevy Van, Beauville, Sport Van, G15-G35, Rally Van, Vandura.)
- (22) Step van or walk-in van ($\leq 4,500$ kgs GVWR)
- (23) Van based motorhome ($\leq 4,500$ kgs GVWR)
- (24) Van based school bus ($\leq 4,500$ kgs GVWR)
- (25) Van based other bus ($\leq 4,500$ kgs GVWR)
- (28) Other van type (Hi-Cube Van, Kary) (specify): _____
- (29) Unknown van type

Light Conventional Trucks (Pickup style cab, $\leq 4,500$ kgs GVWR)

- (30) Compact pickup (D50, Colt P/U, Ram 50, Dakota, Arrow Pickup [foreign], Ranger, Courier, S-10, T-10, LUV, S-15, T-15, Sonoma, Datsun/Nissan Pickup, P'up, Mazda Pickup, Toyota Pickup, Mitsubishi Pickup)
- (31) Large Pickup (Jeep Pickup, Comanche, Ram Pickup, D100-D350, W100-W350, F100-F350, C10-C35, K10-K35, R10-R35, V10-V35, Silverado, Sierra, R100-R500,)

- (32) Pickup with slide-in camper
- (33) Convertible pickup
- (39) Unknown pickup style light conventional truck type

Other Light Trucks ($\leq 4,500$ kgs GVWR)

- (40) Cab chassis based (includes rescue vehicles, light stake, dump, and tow truck)
- (41) Truck based panel
- (42) Light truck based motorhome (chassis mounted)
- (45) Other light conventional truck type
- (48) Unknown light truck type
- (49) Unknown light vehicle type (automobile, utility, van, or light truck)

OTHER VEHICLES

Buses (Excludes Van Based)

- (50) School bus (designed to carry students, not cross country or transit)
- (58) Other bus type (e.g., transit, intercity, bus based motorhome) (specify): _____
- (59) Unknown bus type

Medium/Heavy Trucks ($> 4,500$ kgs GVWR)

- (60) Step van ($> 4,500$ kgs GVWR)
- (61) Single unit straight truck ($4,500$ kgs $<$ GVWR $\leq 8,850$ kgs)
- (62) Single unit straight truck ($8,850$ kgs $<$ GVWR $\leq 12,000$ kgs)
- (63) Single unit straight truck ($> 12,000$ kgs GVWR)
- (64) Single unit straight truck, GVWR unknown
- (65) Medium/heavy truck based motorhome
- (67) Truck-tractor with no cargo trailer
- (68) Truck-tractor pulling one trailer
- (69) Truck-tractor pulling two or more trailers
- (70) Truck-tractor (unknown if pulling trailer)
- (78) Unknown medium/heavy truck type
- (79) Unknown truck type (light/medium/heavy)

Motored Cycles (Does Not Include All-Terrain Vehicles/Cycles)

- (80) Motorcycle
- (81) Moped (motorized bicycle)
- (82) Three-wheel motorcycle or moped
- (88) Other motored cycle (minibike, motorscooter) (specify): _____
- (89) Unknown motored cycle type

Other Vehicles

- (90) ATV (All-Terrain Vehicle) and ATC (All-Terrain Cycle)
- (91) Snowmobile
- (92) Farm equipment other than trucks
- (93) Construction equipment other than trucks
- (97) Other vehicle type
- (99) Unknown body type

VEHICLE WEIGHT ITEMS **RECONSTRUCTION DATA**

15. Vehicle Curb Weight 1,150
 Code weight to nearest 10 kilograms.
 (045) Less than 450 kilograms
 (610) 6,100 kilograms or more
 (999) Unknown

2,524 lbs X .4536 = 1,145 kgs

Source: 

16. Vehicle Cargo Weight 0,000
 Code weight to nearest 10 kilograms.
 (000) Less than 5 kilograms
 (450) 4,500 kilograms or more
 (999) Unknown

_____ lbs X .4536 = 0,000 kgs

18. Impact Speed 041
 Nearest kmph

(NOTE: 000 means greater than .5 kmph)
 (160) 159.5 kmph and above
 (999) Unknown

19. Accuracy Range of Impact Speed Estimate 2
 (0) No reconstruction
 (1) Less than 2 kmph
 (2) ≥ 2 kmph and ≤ 8 kmph
 (3) ≥ 9 kmph and ≤ 16 kmph
 (4) ≥ 17 kmph and ≤ 26 kmph
 (9) Unknown

20. Data Source of Impact Speed 1
 (0) No impact speed calculated
 (1) Zone center calculation
 (2) Police calculation
 (3) Driver/witness/police estimates

OTHER DATA

17. Vehicle Special Use (This Trip) 0
 (0) No special use
 (1) Taxi
 (2) Vehicle used as school bus
 (3) Vehicle used as other bus
 (4) Military
 (5) Police
 (6) Ambulance
 (7) Fire truck or car
 (8) Other (specify): _____
 (9) Unknown

PRECRASH DATA

21. Driver's Attention to Driving 1
 (Prior to Recognition of Critical Event)
 (1) Full attention to driving
 (2) Distracted by other occupant
 (3) Distracted by moving object in vehicle
 (4) Distracted by outside person, object, or event
 (5) Talking on cellular phone or CB radio
 Specify: _____
 (6) Sleeping or dozing while driving
 (8) Other (specify): _____
 (9) Unknown

22. Pre-Event Vehicle Movement 01
 (Prior to Recognition of Critical Event)
 (01) Going straight
 (02) Slowing or stopping in traffic lane
 (03) Starting in traffic lane
 (04) Stopped in traffic lane
 (05) Passing or overtaking another vehicle
 (06) Disabled or parked in travel lane
 (07) Leaving a parking position
 (08) Entering a parking position
 (09) Turning right
 (10) Turning left
 (11) Making a U-turn
 (12) Backing up (other than for parking position)
 (13) Negotiating a curve
 (14) Changing lanes
 (15) Merging
 (16) Successful avoidance maneuver to a previous critical event
 (97) Other (specify): _____
 (98) No driver present
 (99) Unknown

STOP - VARIABLES 18 THROUGH 20 ARE COMPLETED BY THE ZONE CENTER

23. Critical Precrash Event

80*This Vehicle Loss of Control Due To:*

- (01) Blow out or flat tire
- (02) Stalled engine
- (03) Disabling vehicle failure (e.g., wheel fell off) (specify): _____
- (04) Non-disabling vehicle problem (e.g., hood flew up) (specify): _____
- (05) Poor road conditions (puddle, pot hole, ice, etc.) (specify): _____
- (06) Traveling too fast for conditions
- (08) Other cause of control loss (specify): _____

- (09) Unknown cause of control loss

This Vehicle Traveling

- (10) Over the lane line on left side of travel lane
- (11) Over the lane line on right side of travel lane
- (12) Off the edge of the road on the left side
- (13) Off the edge of the road on the right side
- (14) End departure
- (15) Turning left at intersection
- (16) Turning right at intersection
- (17) Crossing over (passing through) intersection
- (19) Unknown travel direction

Other Motor Vehicle In Lane

- (50) Stopped
- (51) Traveling in same direction with lower speed (i.e., lower steady speed or decelerating)
- (52) Traveling in same direction with higher speed
- (53) Traveling in opposite direction
- (54) In crossover
- (55) Backing
- (59) Unknown travel direction of other motor vehicle in lane

Other Motor Vehicle Encroaching Into Lane

- (60) From adjacent lane (same direction)—over left lane line
- (61) From adjacent lane (same direction)—over right lane line
- (62) From opposite direction—over left lane line
- (63) From opposite direction—over right lane line
- (64) From parking lane
- (65) From crossing street, turning into same direction
- (66) From crossing street, across path
- (67) From crossing street, turning into opposite direction
- (68) From crossing street, intended path not known
- (70) From driveway, turning into same direction
- (71) From driveway, across path
- (72) From driveway, turning into opposite direction
- (73) From driveway, intended path not known
- (74) From entrance to limited access highway
- (78) Encroachment by other vehicle—details unknown

Pedestrian or Pedalcyclist, or Other Nonmotorist

- (80) Pedestrian in roadway
- (81) Pedestrian approaching roadway
- (82) Pedestrian—unknown location

- (83) Pedalcyclist or other nonmotorist in roadway (specify): _____
- (84) Pedalcyclist or other nonmotorist approaching roadway (specify): _____
- (85) Pedalcyclist or other nonmotorist—unknown location (specify): _____

Object or Animal

- (87) Animal in roadway
- (88) Animal approaching roadway
- (89) Animal—unknown location
- (90) Object in roadway
- (91) Object approaching roadway
- (92) Object—unknown location
- (98) Other critical precrash event (specify): _____
- (99) Unknown

24. Attempted Avoidance Maneuver

08

- (00) No driver present
- (01) No avoidance actions
- (02) Braking (no lockup)
- (03) Braking (lockup)
- (04) Braking (lockup unknown)
- (05) Releasing brakes
- (06) Steering left
- (07) Steering right
- (08) Braking and steering left
- (09) Braking and steering right
- (10) Accelerating
- (11) Accelerating and steering left
- (12) Accelerating and steering right
- (98) Other action (specify): _____
- (99) Unknown

25. Precrash Stability After Avoidance Maneuver

2

- (0) No driver present
- (1) No avoidance maneuver
- (2) Tracking
- (3) Skidding longitudinally—rotation less than 30 degrees
- (4) Skidding laterally—clockwise rotation
- (5) Skidding laterally—counterclockwise rotation
- (8) Other vehicle loss-of-control (specify): _____
- (9) Precrash stability unknown

26. Precrash Directional Consequences of Avoidance Maneuver (Corrective Action)

2

- (0) No driver present
- (1) No avoidance maneuver
- (2) Vehicle stayed in travel lane where avoidance maneuver was initiated
- (3) Vehicle stayed on roadway but left travel lane where avoidance maneuver was initiated
- (4) Vehicle stayed on roadway, not known if left travel lane where avoidance maneuver was initiated
- (5) Vehicle departed roadway
- (6) Avoidance maneuver initiated off roadway
- (9) Directional consequences unknown

ENVIRONMENTAL DATA

27. Relation to Junction 0
 (0) Non-junction
 (1) Interchange area
Non-Interchange
 (2) Intersection
 (3) Intersection-related
 (4) Drive, alley access related
 (5) Other non-interchange (specify):
 (6) _____
 (9) Unknown if interchange
28. Trafficway Flow 1
 (1) Not physically divided (two way traffic)
 (2) Divided trafficway - median strip without positive barrier
 (3) Divided trafficway - median strip with positive barrier
 (4) One way trafficway
 (9) Unknown
29. Number of Travel Lanes 2
 (1) One
 (2) Two
 (3) Three
 (4) Four
 (5) Five
 (6) Six
 (7) Seven or more
 (9) Unknown
30. Roadway Alignment 1
 (1) Straight
 (2) Curve right
 (3) Curve left
 (9) Unknown
31. Roadway Profile 1
 (1) Level
 (2) Uphill Grade (> 2%)
 (3) Downhill Grade (> 2%)
 (4) Hillcrest
 (5) Sag
 (9) Unknown
32. Roadway Surface Type 2
 (1) Concrete
 (2) Bituminous (asphalt)
 (3) Brick or Block
 (4) Slag, gravel or stone
 (5) Dirt
 (8) Other (specify):
 (9) _____
 Unknown

33. Roadway Surface Condition 1
 (1) Dry
 (2) Wet
 (3) Snow and slush
 (4) Ice
 (5) Sand, dirt or oil
 (8) Other (specify): _____
 (9) Unknown
34. Traffic Control Device 0
 (0) No traffic control(s)
 (1) Trafficway traffic control signal (not RR crossing)
Regulatory or School Zone Sign (Not RR Crossing)
 (2) Stop sign
 (3) Yield sign
 (4) School zone sign
 (5) Other sign (specify):
 (6) _____
 (7) Warning sign (not RR crossing)
 (8) Miscellaneous/other controls including RR controls (specify):
 (9) _____
 Unknown
35. Traffic Control Device Functioning 0
 (0) No traffic control
 (1) Not Functioning
 (2) Functioning
 (9) Unknown
36. Light Conditions 3
 (1) Daylight
 (2) Dark
 (3) Dark, but lighted
 (4) Dawn
 (5) Dusk
 (9) Unknown
37. Atmospheric Conditions 1
 (1) No adverse atmospheric related driving conditions
 (2) Rain
 (3) Sleet
 (4) Snow
 (5) Fog
 (6) Rain and fog
 (7) Sleet and fog
 (8) Other (e.g., smog, smoke, blowing sand or dust, etc.) (specify): _____
 (9) Unknown

BEST AVAILABLE COPY

99-619P

'92 Eclipse

1940m

2740m

66"

135#

POI to FRP = 28.4m = 93 ft.

f = 0.6

25-30

brake / st... 1.1 ft

20-30 input

PRT = 1.5 Sec

$$93 = 1.5V + \frac{V^2}{(2)(0.6)(32.2)}$$

$$0.026V^2 + 1.5V - 93 = 0$$

$$V = \frac{-1.5 \pm \sqrt{(1.5)^2 - (4)(0.026)(-93)}}{0.052}$$

$$V = 37 \text{ fps} = 25.6 \text{ mph} = 41.2 \text{ KPH}$$



1. Primary Sampling Unit Number	<u>49</u>	3. Vehicle Number	<u>01</u>
2. Case Number - Stratum	<u>619P</u>		

VEHICLE IDENTIFICATION

VIN 4A3CS34T7NE  Model Year 92

Vehicle Make (specify): Mitsubishi Vehicle Model (specify): Eclipse

PEDESTRIAN FRONT CONTACT WORK SHEET

PEV06 Hood Material Steel

PEV08 Hood Length _____ cm

PEV09 Hood Width-Forward Opening _____ cm

PEV10 Hood Width-Midway _____ cm

PEV11 Hood Width-Rear Opening _____ cm

PEV14 Front Bumper Cover Material _____

PEV15 Front Bumper Reinforcement Material _____

VERTICAL MEASUREMENTS

PEV16 Front Bumper-Bottom Height _____ cm

PEV17 Front Bumper-Top Height _____ cm

PEV18 Forward Hood Opening _____ cm

PEV19 Front Bumper Lead _____ cm

WRAP DISTANCES

PEV20 Ground to Forward Hood Opening _____ cm

PEV21 Ground to Front/Top Transition Point _____ cm

PEV22 Ground to Rear Hood Opening _____ cm

PEV23 Ground to Base of Windshield _____ cm

PEV24 Ground to Top of Windshield _____ cm

PEV25 Ground to Head Contact _____ cm

VEHICLE DAMAGE SKETCH

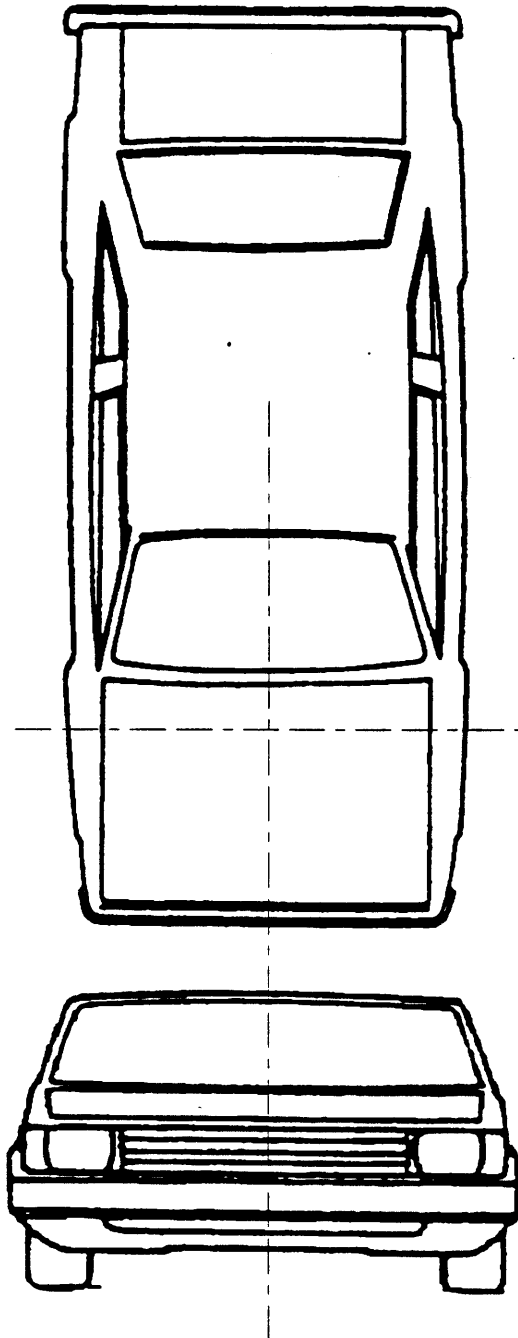

NOTES: Sketch all pedestrian contacts, include the size and depth in centimeters. Locate the pedestrian contacts from the intercept point of the centerline (lateral) and the front axles (longitudinal) in centimeters. Annotate observations which might be useful in reconstructing the accident (e.g., grass in tire bead, direction of striations, scuff on sidewalls, etc.).

Location of the origin (intercept point of the centerline and the front axles) from the ground: _____ cm

PEDESTRIAN SIDE CONTACT WORK SHEET

PEV06 Hood Material

Steel

PEV08 Hood Length

116 cm

PEV09 Hood Width-Forward Opening

129 cm

PEV10 Hood Width-Midway

138 cm

PEV11 Hood Width-Rear Opening

139 cm

VERTICAL MEASUREMENTS

PEV26 Ground Clearance

021 cm

PEV27 Side Bumper-Bottom Height

038 cm

PEV28 Side Bumper-Top Height

055 cm

PEV29 Centerline of Wheel

028 cm

PEV30 Top of Tire

059 cm

PEV31 Top of Wheel Well Opening

067 cm

PEV32 Bottom of A-Pillar at Windshield

089 cm

PEV33 Top of A-Pillar at Windshield

121 cm

PEV34 Top of Side View Mirror

095 cm

LATERAL MEASUREMENTS

PEV35 C_L to A-Pillar at Bottom of Windshield074 cmPEV36 C_L to A-Pillar at Top of Windshield055 cmPEV37 C_L to Maximum Side View Mirror Protrusion094 cm

WRAP DISTANCES

PEV38 Ground to Side/Top Transition

084 cm

PEV39 Ground to Hood Edge

090 cm

PEV40 Ground to Centerline of Hood (ORIGIN)

160 cm

PEV41 Ground to Head Contact

--- cm

ORIGINAL SPECIFICATIONS

Wheelbase	97.2	inches	x 2.54	=	247	cm
Overall Length	172.8	inches	x 2.54	=	439	cm
Maximum Width	66.7	inches	x 2.54	=	169	cm
Curb Weight	2524	pounds	x .4536	=	1145	kg
Average Track	57.4	inches	x 2.54	=	146	cm
Front Overhang	—	inches	x 2.54	=	99	cm
Rear Overhang	—	inches	x 2.54	=	93	cm
Undeformed End Width	—	inches	x 2.54	=	134	cm
Engine Size: cyl./displ.	—	cc	x .001	=	1.8	L
	—	CID	x .0164	=	—	L

INJURY SOURCE

FRONT

- 700 Front bumper
- 701 Front lower valance/spoiler
- 702 Front grille
- 703 Hood edge and/or trim
- 704 Hood ornament (fixed)
- 705 Hood ornament (spring loaded)
- 706 Headlight
- 707 Retractable headlight door (Open/Closed)
- 708 Turn signal/parking lights
- 718 Other front or add on object
(specify): _____
- 719 Unknown front object

Left Side Components

- 720 Front fender side surface
- 721 Front antenna
- 722 A1 pillar
- 723 A2 pillar
- 724 B pillar
- 725 C pillar
- 726 D pillar
- 728 Other pillar
(specify): _____
- 729 Left side roof rail
- 730 Left side door surface
- 731 Left side door handle
- 732 Left side mirror fixed housing
- 733 Left side folding mirror
- 734 Left side glazing forward of B pillar
- 735 Left side glazing rearward of B pillar
- 736 Left side back fender or quarter panel
- 737 Rear antenna
- 738 Other left side object
(specify): _____
- 739 Unknown left side component

Right Side Components

- 740 Front fender side surface
- 741 Front antenna
- 742 A1 pillar
- 743 A2 pillar

- 744 B pillar
- 745 C pillar
- 746 D pillar
- 748 Other pillar (specify): _____
- 749 Right side roof rail
- 750 Right side door surface
- 751 Right side door handle
- 752 Right side mirror fixed housing
- 753 Right side folding mirror
- 754 Right side glazing forward of B pillar
- 755 Right side glazing rearward of B pillar
- 756 Rear antenna
- 757 Rear fender or quarter panel
- 758 Other right side object
(specify): _____
- 759 Unknown right side component

Back Components

- 760 Rear (back) bumper
- 761 Tailgate
- 762 Hatchback, vertical surface
- 768 Other back component
(specify): _____
- 769 Unknown back component

Top Components

- 770 Hood surface
- 771 Hood surface reinforced by under hood component
- 772 Front fender top surface
- 773 Cowl area
- 774 Wiper blade & mountings
- 775 Windshield glazing
- 776 Front header
- 777 Roof surface
- 778 Backlight glazing
- 779 Rear header
- 780 Hatchback
- 781 Rear trunk lid
- 788 Other top component (specify): _____
- 789 Unknown top component

Wheels / tires

- 790 Left front wheel / tire
- 791 Right front wheel / tire
- 792 Left rear wheel / tire
- 793 Right rear wheel / tire
- 798 Other wheel / tire (specify): _____
- 799 Unknown wheel / tire

Undercarriage components

- 800 Front cross member
- 801 Steering assembly/Front suspension
- 802 Oil pan
- 803 Exhaust system pipe
- 804 Transmission
- 805 Drive shaft
- 806 Catalytic converter
- 807 Muffler
- 808 Floor pan
- 809 Fuel tank
- 810 Rear suspension
- 818 Other undercarriage component
(specify): _____
- 819 Unknown undercarriage component

Accessories

- 820 Air scoop, deflector
- 821 Cellular or CB radio antenna
- 822 Emergency lights or bar
- 823 Fog lights
- 824 Luggage, ski, or bike rack
- 825 Cargo (specify): _____
- 826 Spare tire
- 827 Spotlight
- 828 Other accessory (specify): _____

Other Object or Vehicle in Environment

- 947 Ground
- 948 Other object (specify): _____
- 949 Unknown object in environment
- 959 Unknown object on contacting vehicle
- 997 Noncontact injury source
- 999 Unknown injury source

VEHICLE DAMAGE SKETCH

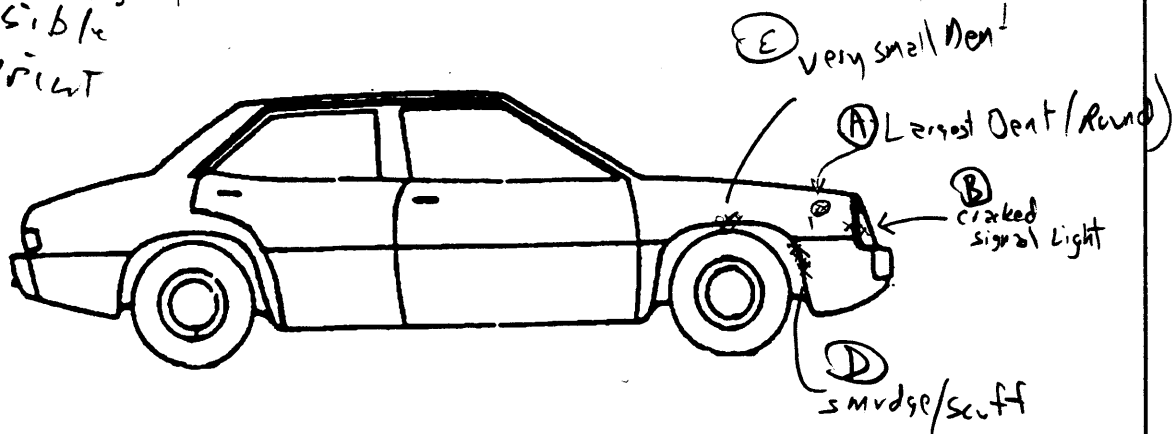
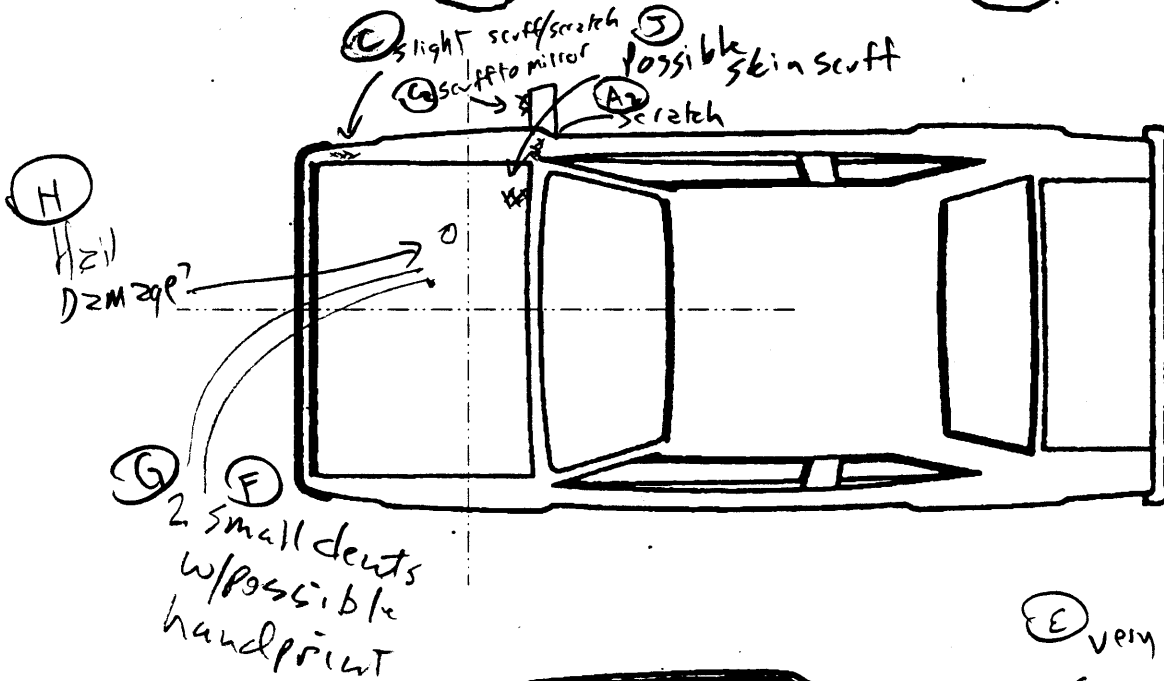
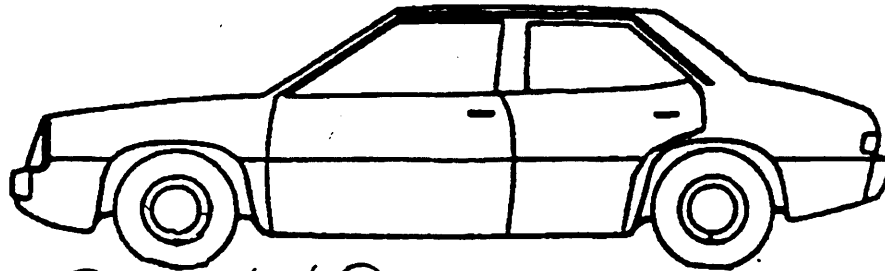

NOTES: Sketch all pedestrian contacts, include the size and depth in centimeters. Locate the pedestrian contacts from the intercept point of the centerline (lateral) and the front axes (longitudinal) in centimeters. Annotate observations which might be useful in reconstructing the accident (e.g., grass in tire bead, direction of striations, scuff on sidewalls, etc.).

Location of the origin (intercept point of the centerline and the front axes) from the ground: 160 cm

POINTS OF PEDESTRIAN CONTACT								
PEDESTRIAN CONTACT WORKSHEET								
CONTACT ID LABEL	COMPONENT CONTACTED	LONGITUDINAL LOCATION (X)	LATERAL LOCATION (Y)	CRUSH IN CENTIMETERS	SUSPECTED BODY REGION	SUPPORTING PHYSICAL EVIDENCE	CONFIDENCE LEVEL OF CONTACT POINT (Circle)	SEQUENCE #
A	Rt. Fender	62	75	1	R knee	Dent-round	1 2 3 9	2
		65	75				1 2 3 9	
B	Rt. Turn Light	63-74	193	1	belly	Cracked	1 2 3 9	1
		63-74	193				1 2 3 9	
C	R.F. Fender	68	72	1	Thigh?	scuff/scratch	1 2 3 9	3
		68	72				1 2 3 9	
D	R.F. Fender	47	96	1	R/L leg	Scuff	1 2 3 9	4
		47	96				1 2 3 9	
E	Fender wall	2	92	1	L Leg	Dent	1 2 3 9	5
		2	92				1 2 3 9	
F	Hood	11	17	1	hand	Dent	1 2 3 9	6
		11	17				1 2 3 9	
G	Hood	29	20	1	hand	Dent (possible heel)	1 2 3 9	7
		29	20				1 2 3 9	
H	Hood	-12	44	1	unk. belt	Dent (possible heel)	1 2 3 9	8
		-12	44				1 2 3 9	
J	Hood	-34	98	1	Elbow(?)	Scuff	1 2 3 9	
		-34	98				1 2 3 9	
A ₂	Back of R.F. Fender	-49	76	1	?	scratch	1 2 3 9	9
		-49	76				1 2 3 9	
C ₂	R Midland	-69	-90	1	?	cloth leader	1 2 3 9	10
		-69	-90				1 2 3 9	
							1 2 3 9	
							1 2 3 9	
							1 2 3 9	

VEHICLE DIMENSIONS

4. Original Wheelbase 247
 _____ Code to the nearest centimeter
 (999) Unknown

_____ inches X 2.54 = _____ centimeters

5. Original Average Track Width 146
 _____ Code to the nearest centimeter
 (185) 185 centimeters or more
 (999) Unknown

_____ inches X 2.54 = _____ centimeters

6. Hood Material 3
 (1) Plastic
 (2) Fiberglass
 (3) Steel
 (4) Aluminum
 (5) Stainless Steel
 (8) Other (specify): _____
 (9) Unknown

7. Hood Original 1
 Equipment Manufacturer (OEM)
 (1) OEM factory installed hood
 (2) OEM replacement
 (3) Non-OEM replacement
 (9) Unknown

8. Hood Length 116
 _____ Code to the nearest centimeter
 (180) 180 centimeters or more
 (999) Unknown

_____ inches X 2.54 = _____ centimeter

9. Hood Width Forward Opening 129
 _____ Code to the nearest centimeter
 (210) 210 centimeters or more
 (999) Unknown

_____ inches X 2.54 = _____ centimeters

10. Hood Width Midway 138
 _____ Code to the nearest centimeter
 (210) 210 centimeters or more
 (999) Unknown

_____ inches X 2.54 = _____ centimeters

11. Hood Width Rear Opening 139
 _____ Code to the nearest centimeter
 (210) 210 centimeters or more
 (999) Unknown

_____ inches X 2.54 = _____ centimeters

12. Hood/Fender Vertical/Lateral Crush From Pedestrian 2
 (0) Not damaged
 (1) Surface scratching only, no residual crush
 (2) Minor crush (1-3 centimeters)
 (3) Moderate crush (4-7 centimeters)
 (4) Severe crush (> 7 centimeters)
 (8) Damage present, unknown if damage is from pedestrian impact
 (9) Unknown

13. Windshield Contact Damage From Pedestrian Contact 0
 (0) Not contacted by pedestrian
 (1) Contacted by pedestrian - not damaged
 (2) Contacted by pedestrian - damaged
 (3) Unknown if contacted by pedestrian - not damaged
 (4) Unknown if contacted by pedestrian - damaged
 (9) Unknown if contacted by pedestrian - unknown if damaged

FRONT CONTACT DAMAGE

Front Vertical Measurements

14. Front Bumper Cover Material 0 ~~X~~
 (0) No front contact
 (1) Plastic
 (2) Fiberglass
 (3) Rubber
 (4) Other (specify): _____
 (9) Unknown

15. Front Bumper Reinforcement Material 0 ~~X~~
 (0) No front contact
 (1) Steel
 (2) Aluminum
 (3) Stainless Steel
 (4) Other (specify): 000
 (9) Unknown

16. Front Bumper-Bottom Height 999
 _____ Code to the nearest centimeter
 (000) No front contact
 (150) 150 centimeters or more
 (999) Unknown

_____ inches X 2.54 = _____ centimeters

17. Front Bumper-Top Height 999
 Code to the nearest centimeter
 (000) No front contact 000
 (150) 150 centimeters or more
 (999) Unknown

_____ inches X 2.54 = _____ centimeters

18. Forward Hood Opening 999
 Code to the nearest centimeter
 (000) No front contact 000
 (200) 200 centimeters or more
 (999) Unknown

_____ inches X 2.54 = _____ centimeters

19. Front Bumper Lead 99
 (00) No front contact 00
 Code to the nearest centimeter
 (30) 30 centimeters or more
 (99) Unknown

_____ inches X 2.54 = _____ centimeters

23. Ground to Base of Windshield 999
 Code to the nearest centimeter
 (000) No front contact 000
 (400) 400 centimeters or more
 (999) Unknown

_____ inches X 2.54 = _____ centimeters

24. Ground to Top of Windshield 999
 Code to the nearest centimeter
 (000) No front contact 000
 (500) 500 centimeters or more
 (999) Unknown

_____ inches X 2.54 = _____ centimeters

25. Ground To Head Contact 999
 Code to the nearest centimeter
 (000) No front contact 000
 (400) 400 centimeters or more
 (998) No head contact
 (999) Unknown

_____ inches X 2.54 = _____ centimeters

Front Wrap Distance Measurements

20. Ground to Forward Hood Opening 000
 Code to the nearest centimeter
 (000) No front contact 000
 (200) 200 centimeters or more
 (999) Unknown

_____ inches X 2.54 = _____ centimeters

21. Ground to Front/Top Transition Point 999
 Code to the nearest centimeter
 (000) No front contact 000
 (180) 180 centimeters or more
 (999) Unknown

_____ inches X 2.54 = _____ centimeters

22. Ground to Rear Hood Opening 999
 Code to the nearest centimeter
 (000) No front contact 000
 (400) 400 centimeters or more
 (999) Unknown

_____ inches X 2.54 = _____ centimeters

SIDE CONTACT DAMAGE

Side Vertical Measurements

26. Ground Clearance 021
 Code to the nearest centimeter
 (000) No side contact
 (150) 150 centimeters or more
 (999) Unknown

_____ inches X 2.54 = _____ centimeters

27. Side Bumper-Bottom Height 038
 Code to the nearest centimeter
 (000) No side contact
 (150) 150 centimeters or more
 (999) Unknown

_____ inches X 2.54 = _____ centimeters

28. Side Bumper-Top Height 055
 Code to the nearest centimeter
 (000) No side contact
 (150) 150 centimeters or more
 (999) Unknown

_____ inches X 2.54 = _____ centimeters

29. Centerline of Wheel 028
 _____ Code to the
 _____ nearest centimeter
 (000) No side contact
 (150) 150 centimeters or more
 (999) Unknown
 _____ inches X 2.54 = _____ centimeters

30. Top of Tire 059
 _____ Code to the
 _____ nearest centimeter
 (000) No side contact
 (200) 200 centimeters or more
 (999) Unknown
 _____ inches X 2.54 = _____ centimeters

31. Top of Wheel Well Opening 067
 _____ Code to the
 _____ nearest centimeter
 (000) No side contact
 (250) 250 centimeters or more
 (999) Unknown
 _____ inches X 2.54 = _____ centimeters

32. Bottom of A-Pillar at Windshield 089
 _____ Code to the
 _____ nearest centimeter
 (000) No side contact
 (250) 250 centimeters or more
 (999) Unknown
 _____ inches X 2.54 = _____ centimeters

33. Top of A-Pillar at Windshield 121
 _____ Code to the
 _____ nearest centimeter
 (000) No side contact
 (300) 300 centimeters or more
 (999) Unknown
 _____ inches X 2.54 = _____ centimeters

34. Top of Side View Mirror 095
 _____ Code to the
 _____ nearest centimeter
 (000) No side contact
 (300) 300 centimeters or more
 (999) Unknown
 _____ inches X 2.54 = _____ centimeters

Side Lateral Measurements

35. Centerline to A-Pillar 074
 at Bottom of Windshield
 (000) No side contact
 _____ Code to the
 _____ nearest centimeter
 (250) 250 centimeters or more
 (999) Unknown
 _____ inches X 2.54 = _____ centimeters

36. Centerline to A-Pillar 055
 at Top of Windshield
 _____ Code to the
 _____ nearest centimeter
 (000) No side contact
 (250) 250 centimeters or more
 (999) Unknown
 _____ inches X 2.54 = _____ centimeter

37. Centerline to Maximum Side 094
 View Mirror Protrusion
 _____ Code to the
 _____ nearest centimeter
 (000) No side contact
 (300) 300 centimeters or more
 (999) Unknown
 _____ inches X 2.54 = _____ centimeter

Side Wrap Distance Measurements

38. Ground to Side/Top Transition 084
 _____ Code to the
 _____ nearest centimeter
 (000) No side contact
 (400) 400 centimeters or more
 (999) Unknown
 _____ inches X 2.54 = _____ centimeters

39. Ground to Hood Edge 090
 _____ Code to the
 _____ nearest centimeter
 (000) No side contact
 (500) 500 centimeters or more
 (999) Unknown
 _____ inches X 2.54 = _____ centimeters

40. Ground to Centerline of Hood 160
Code to the nearest centimeter
(000) No side contact
(700) 700 centimeters or more
(999) Unknown

_____ inches X 2.54 = _____ centimeters

41. Ground to Head Contact 998
Code to the nearest centimeter
(000) No side contact
(800) 800 centimeters or more
(998) No head contact
(999) Unknown

_____ inches X 2.54 = _____ centimeters

